

RIJEKA 1:50

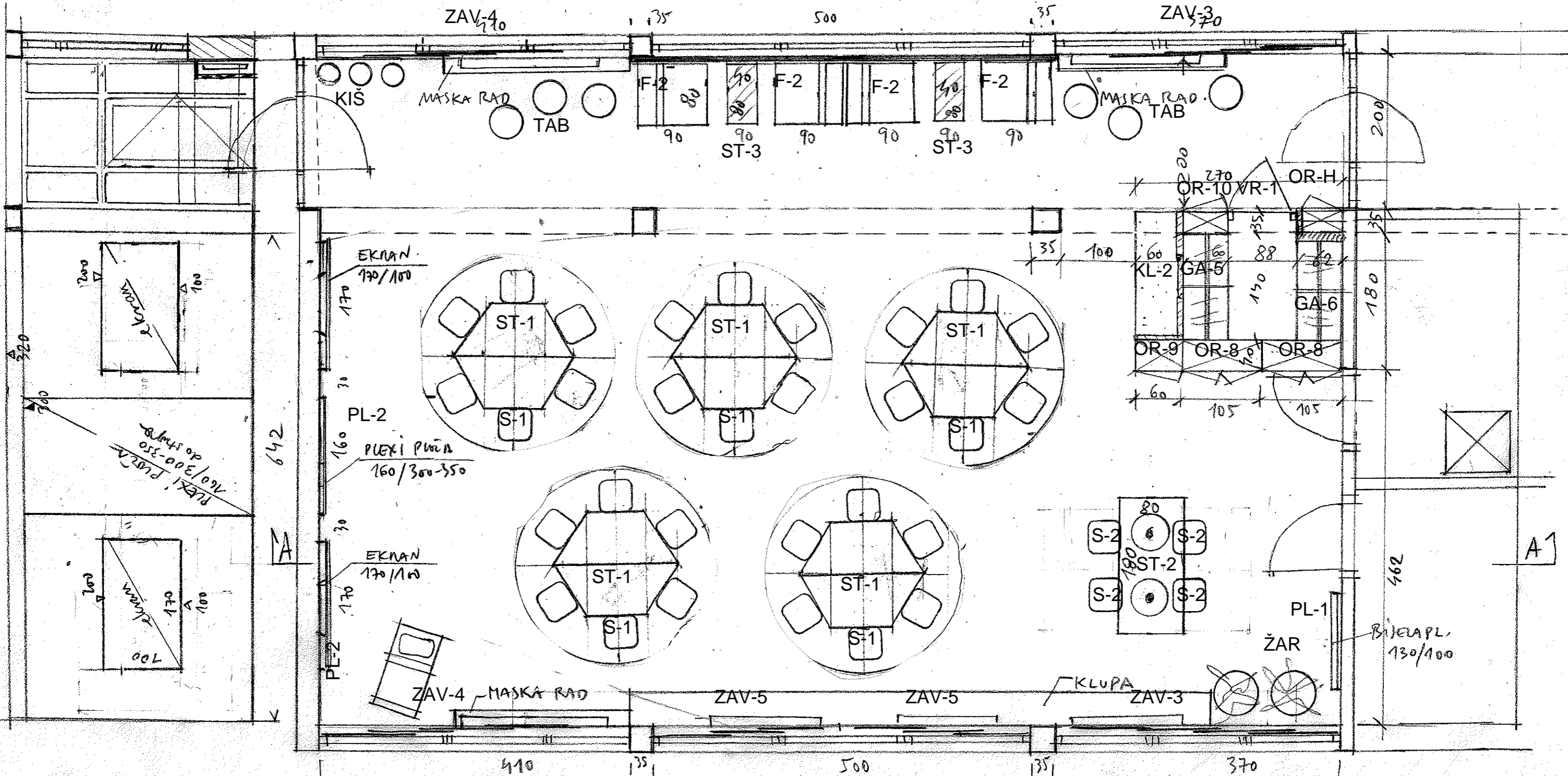

OSIJEK

1:50

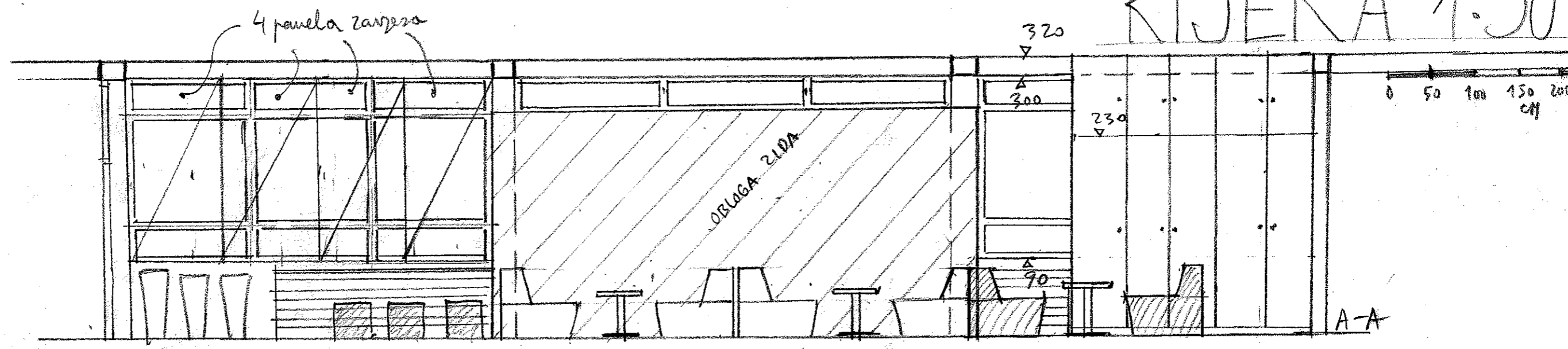
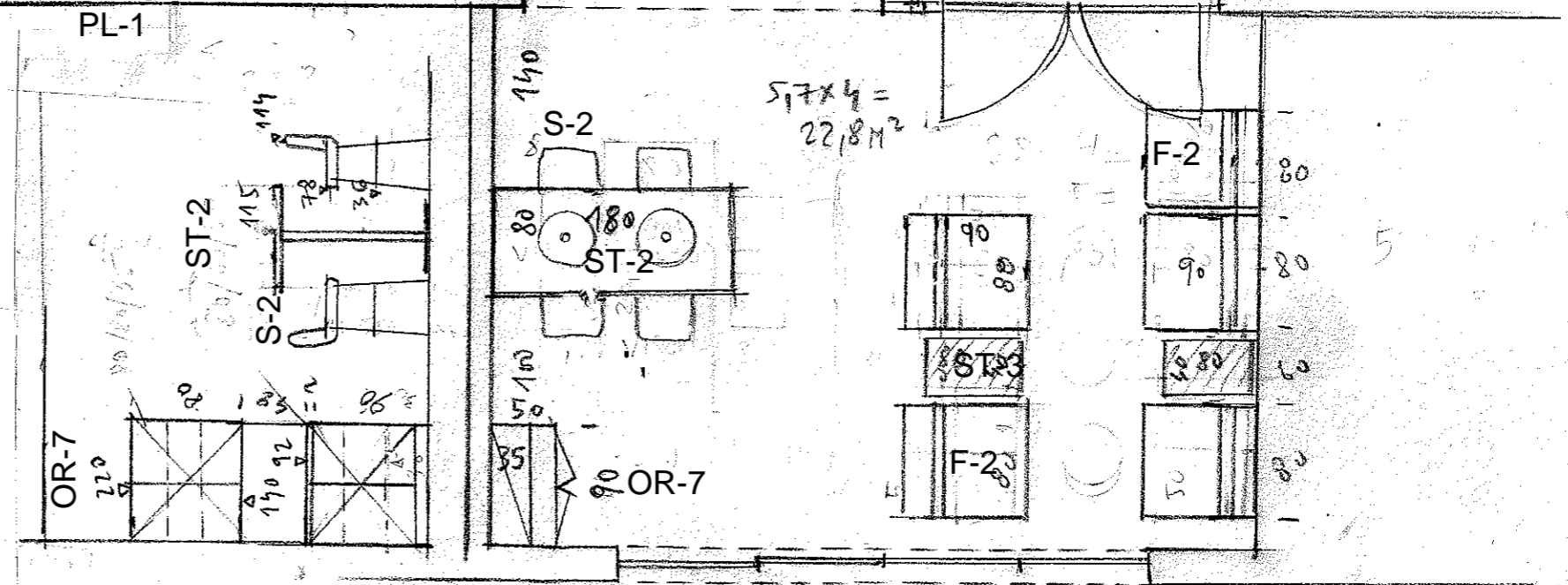
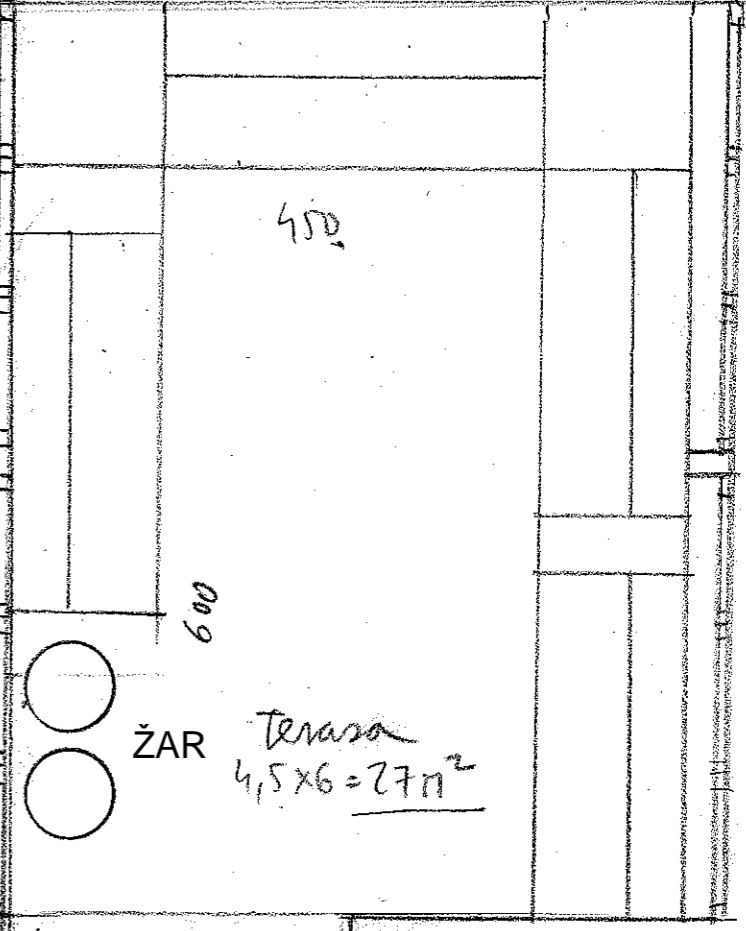
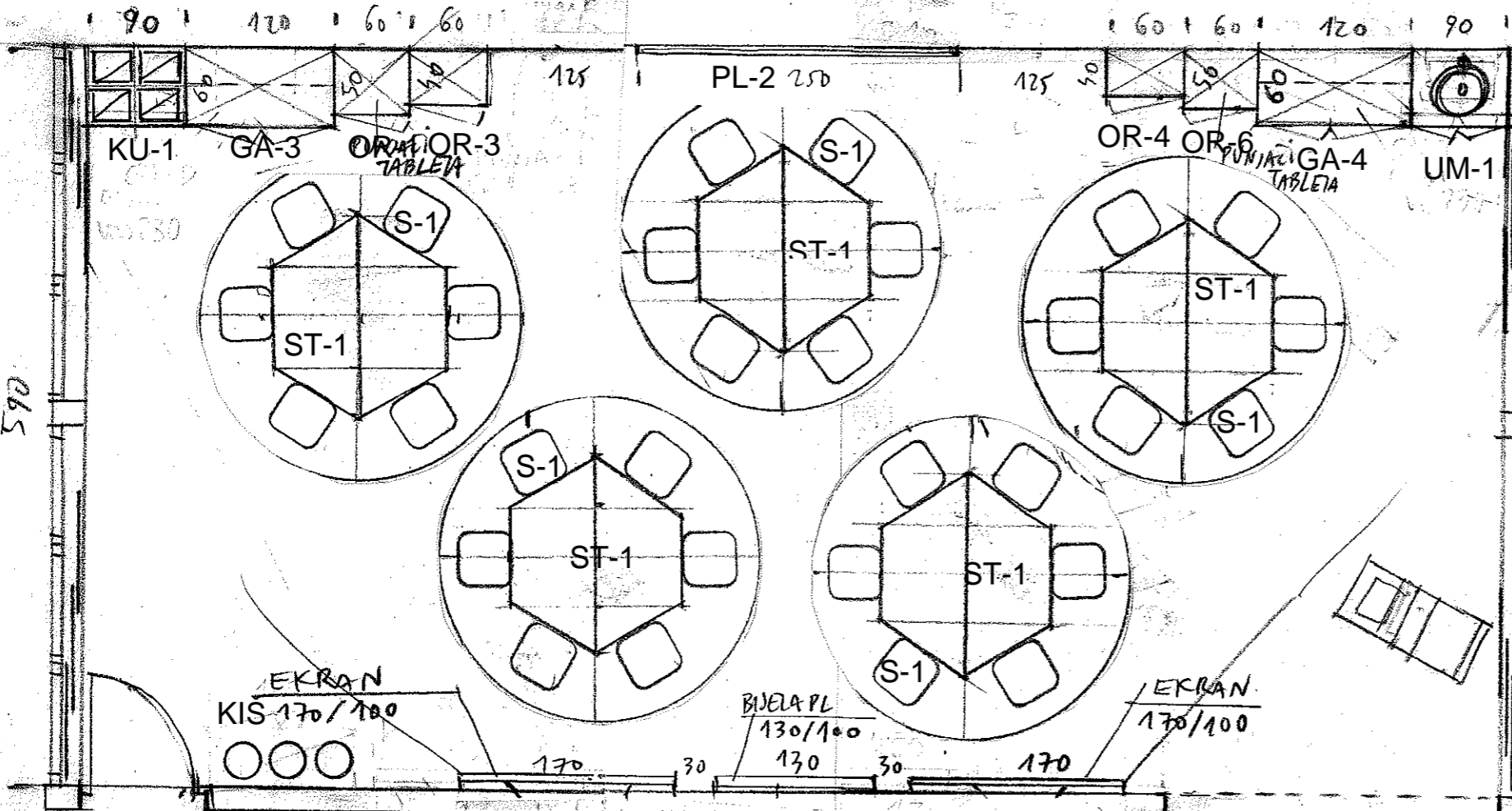
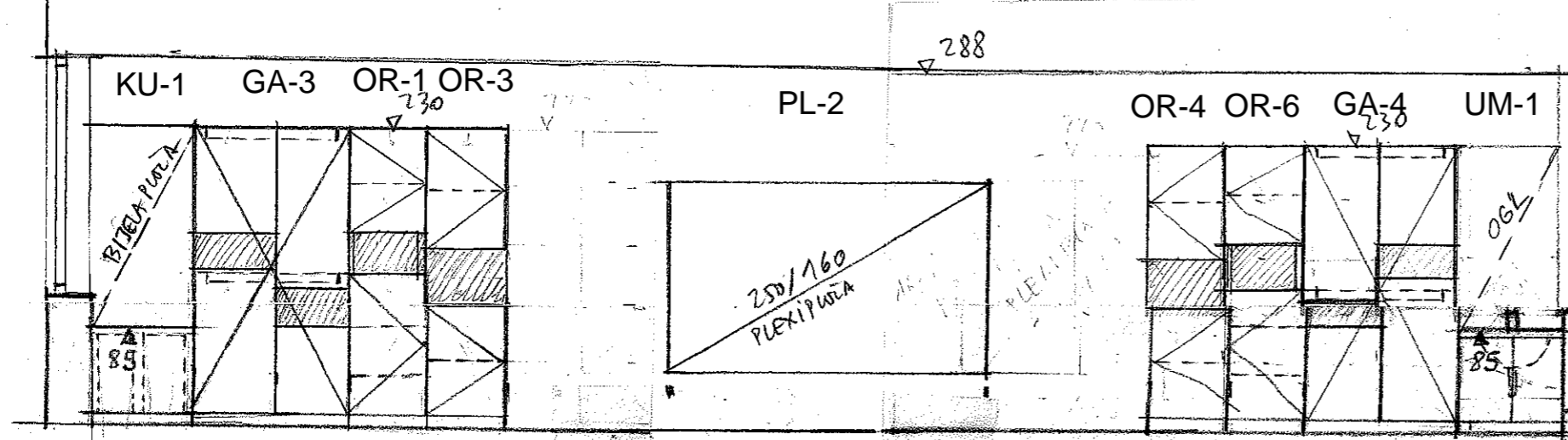
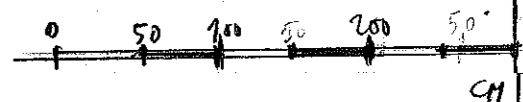

SPLIT
1:50

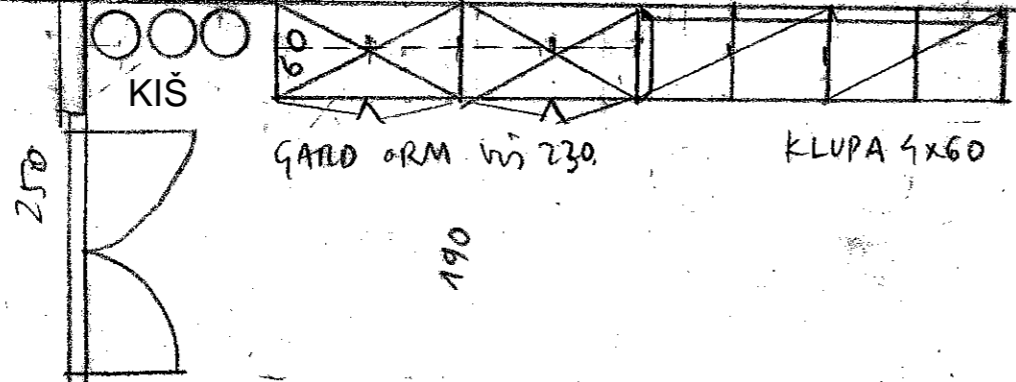
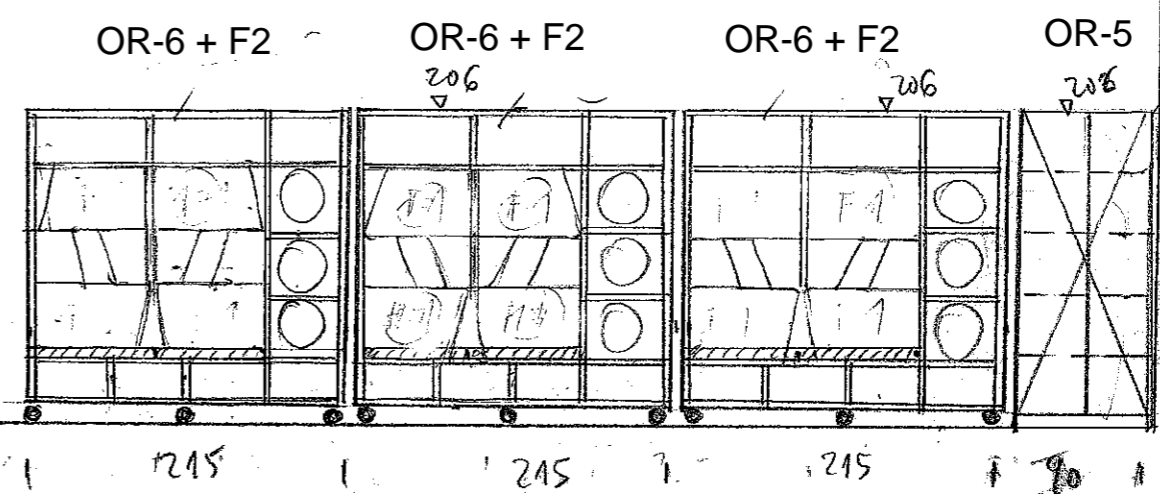
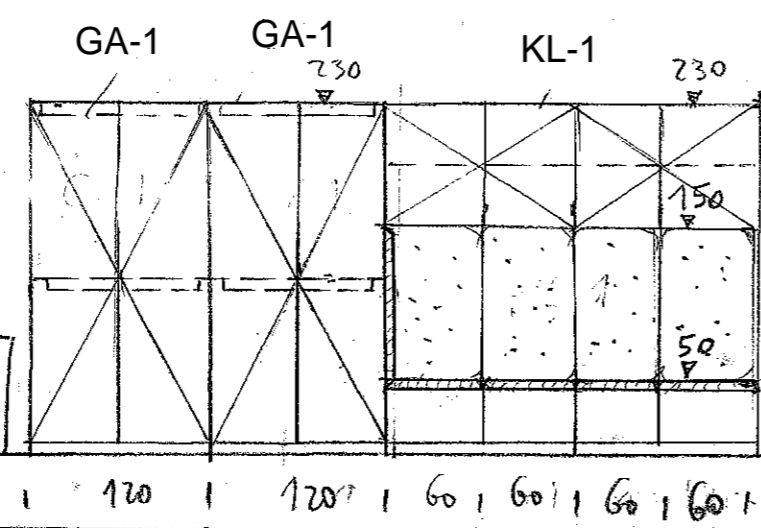
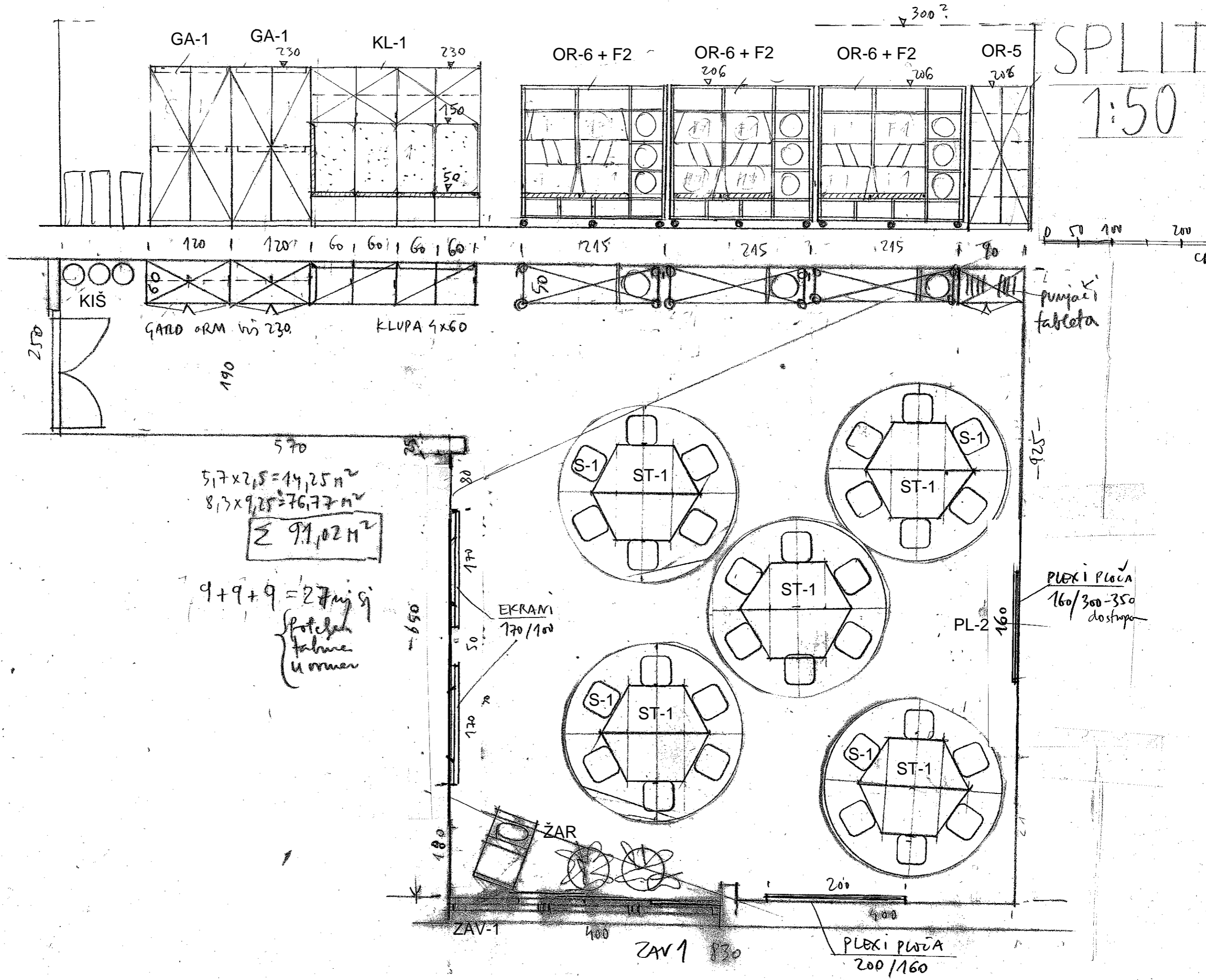

5,7 x 2,5 = 14,25 m²
 8,3 x 9,25 = 76,77 m²
Σ 91,02 m²

9 + 9 + 9 = 27 m² s
 { stolice
 tabure
 u ornam

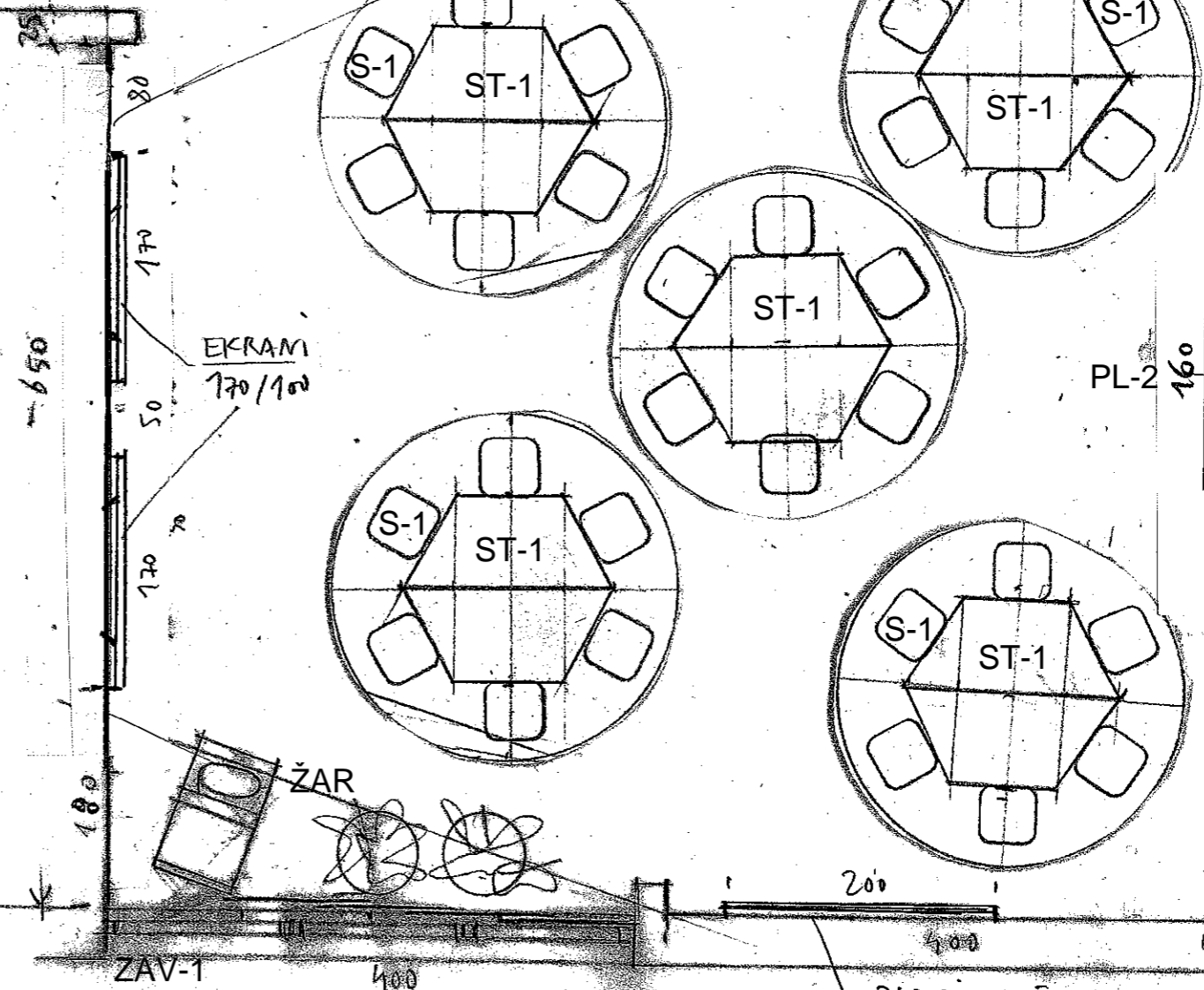

ZAGREB

1:50

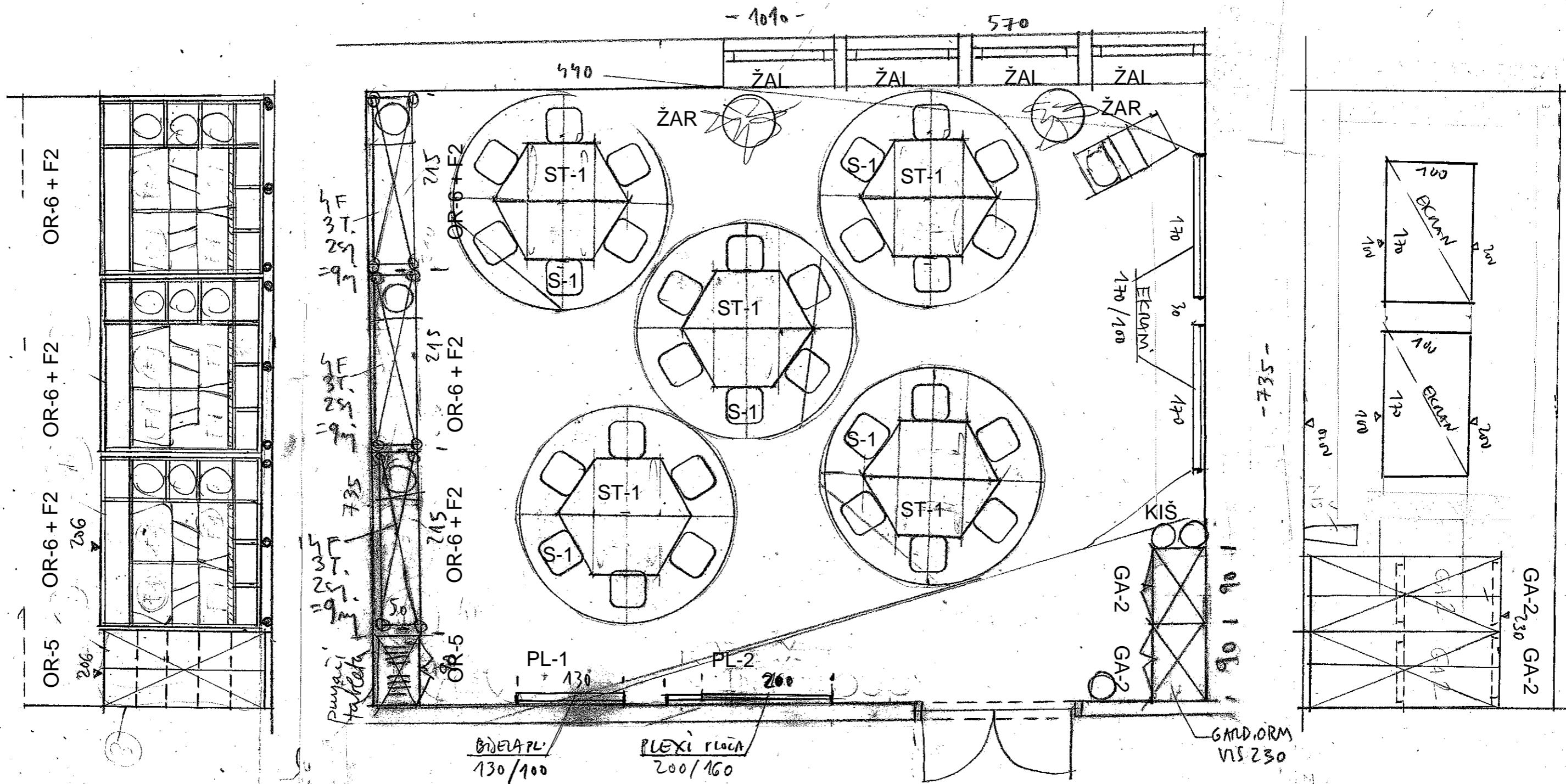

VARAŽDIN

1:50

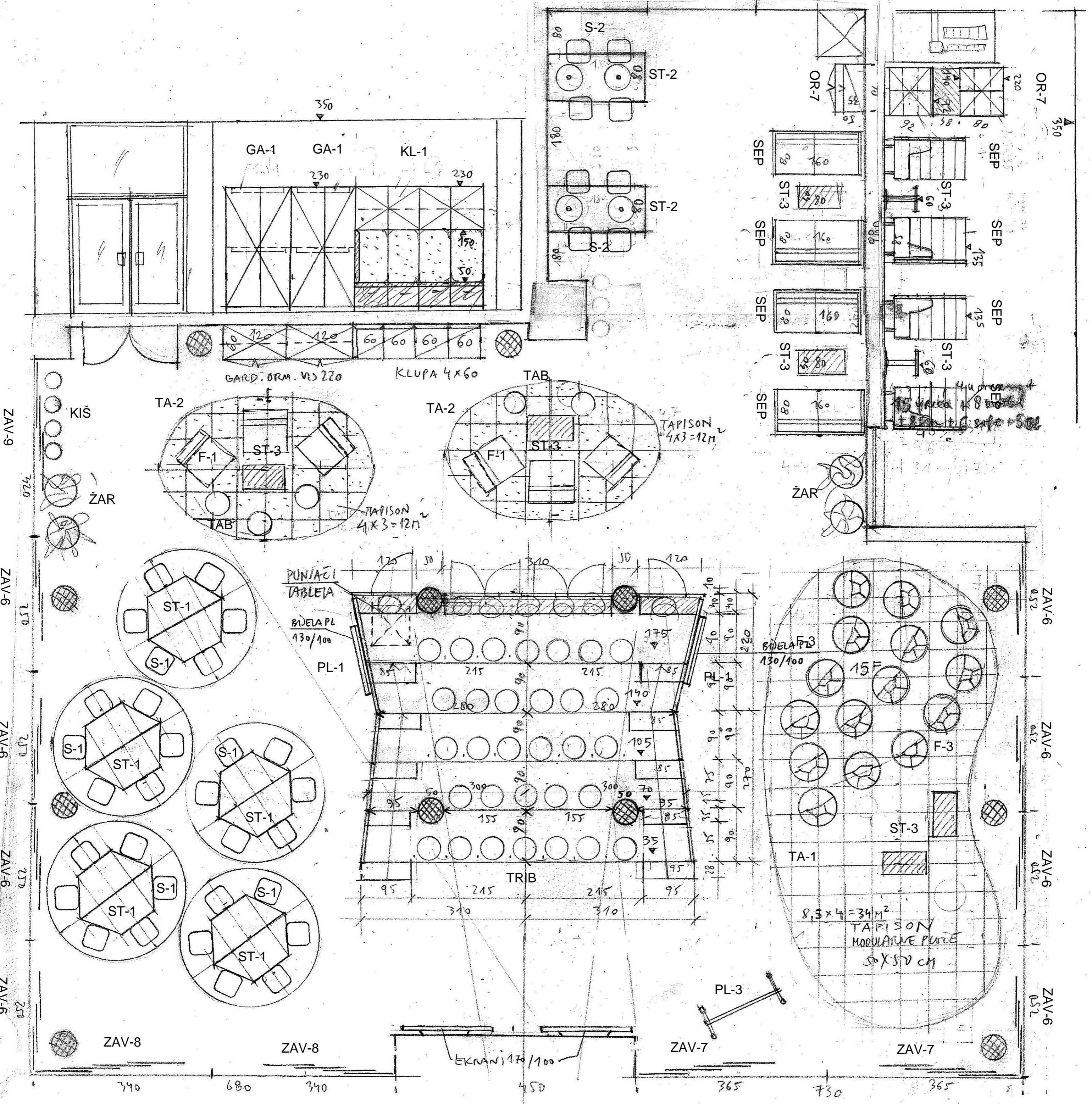
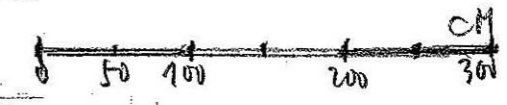

ZAV-9
ZAV-6
ZAV-6
ZAV-6
ZAV-6
ZAV-6

OR-7
SEP
SEP
SEP
SEP
SEP
ZAV-6
ZAV-6
ZAV-6
ZAV-6
ZAV-6

ZAV-8
ZAV-8
ZAV-7
ZAV-7

390 680 340 450 365 730 365